

NOTES: UNLESS OTHERWISE SPECIFIED

**DIMENSION**

1. LASER CUT PATTERN
  - INTERRUPTED SPIRAL CUT PATTERN
  - LASER CUT KERF = 0.0012 ± 0.0003 [0.0254MM]
  - PITCH = 0.010 [0.254MM]
  - CUT ANGLE = 80°
  - UNCUT ANGLE = 22.85°
  - CPR = 3.5

**RAW MATERIAL**

2. 1/4 OD X .014 STANDARD GAUGE AND TOLERANCING
3. 304 SS, FULL HARD

**CLEANING AND PASSIVATION**

4. PARTS FREE OF OIL, DIRT, CONTAMINATION, ETC.
5. PARTS CLEANED PER ASTM A380
6. PARTS PASSIVATED PER ASTM-A967, NITRIC 2

**PACKAGING**

7. PARTS PACKAGED IN CLEAR, SEALED BAGS
8. PARTS PACKAGED IN A MANNER THAT PREVENTS DAMAGE DURING SHIPPING
9. BAGS TO BE LABELED WITH FOLLOWING INFORMATION:
  - SUPPLIER NAME
  - SUPPLIER LOT NUMBER
  - SUPPLIER PART NUMBER
  - PART QUANTITY

**DOCUMENTATION**

10. CERTIFICATION OF CONFORMANCE TO ACCOMPANY EACH SHIPMENT AND SHALL INCLUDE THE FOLLOWING INFORMATION:
  - SUPPLIER NAME
  - SUPPLIER LOT NUMBER
  - SUPPLIER PART NUMBER
  - PART QUANTITY
  - PO NUMBER
  - MATERIAL INFORMATION
  - CONFORMANCE STATEMENT TO DRAWING

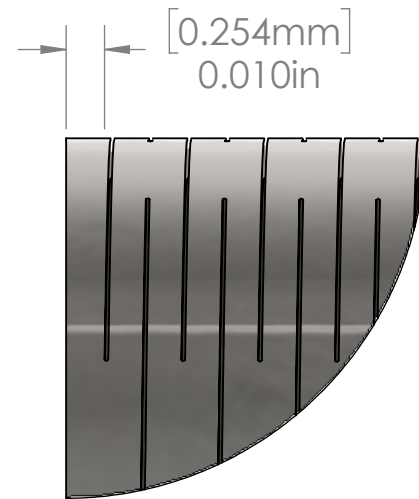
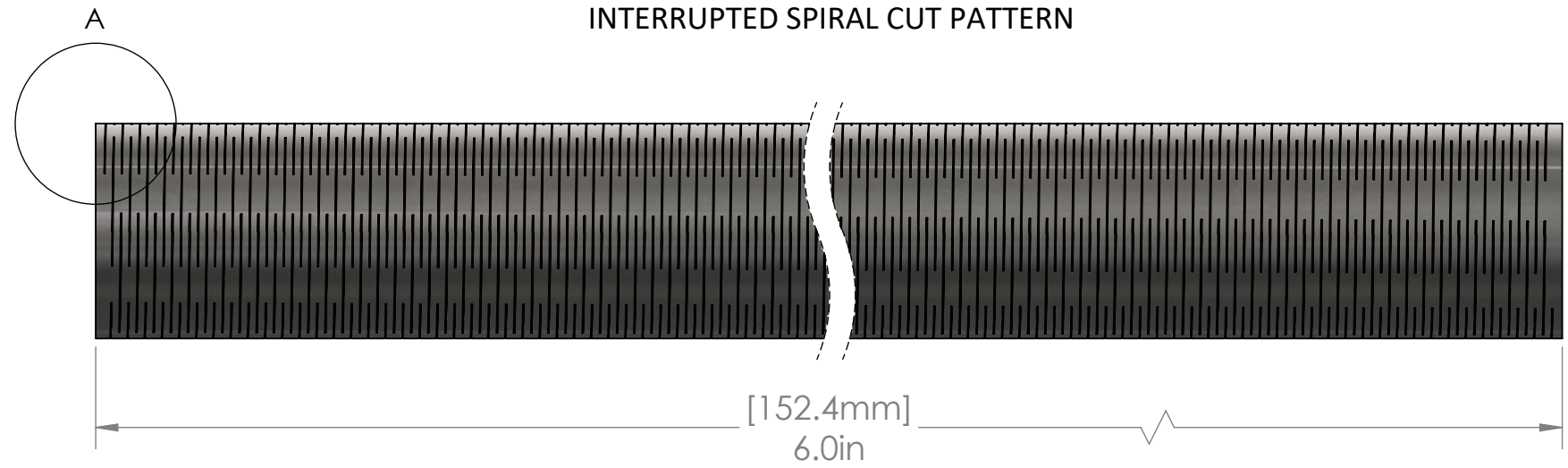

DETAIL A  
SCALE 20 : 1

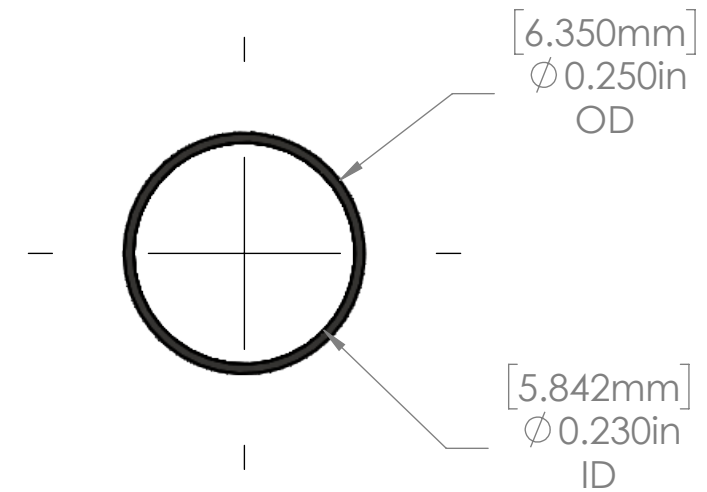

DIMENSIONS ARE IN INCHES, UNLESS OTHERWISE SPECIFIED

.X ± .1  
.XX ± .01  
.XXX ± .001  
ANGLES: ± 3°

INTERPRET PER LATEST ASME Y14.5

MATERIAL: 304 SS



CONFIDENTIAL AND PROPRIETARY

THIS DRAWING CONTAINS CONFIDENTIAL AND PROPRIETARY INFORMATION THAT IS THE SOLE PROPERTY OF SYMMETRY LLC. DISCLOSURE OF SAID INFORMATION DOES NOT CONSTITUTE THE RELEASE OF ANY PROPRIETARY RIGHTS THEREIN

20F LCHT - 0.250 x 0.230 - 0.010  
Pitch, 80 Cut 22.85 Uncut (3.5 CPR)

SIZE  
B

PART NUMBER:  
**SY-028130**

DO NOT SCALE

SCALE 5:1

SHEET 1 OF 1